

# TANGRAM – TRACE 74280

PROJECT PROJÉT
SPEC TYPE
NOTES

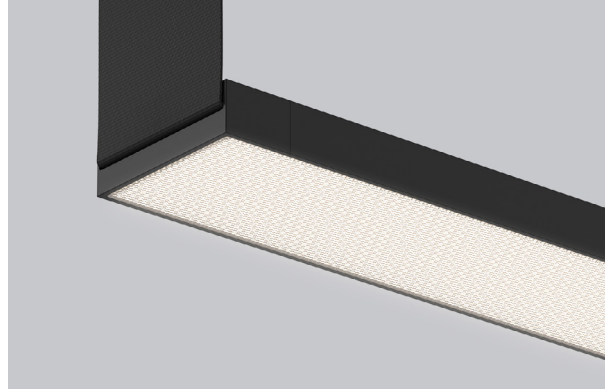

## FINISH FINI

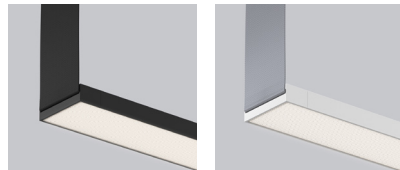

BLKE

WHE

## STRAP FINISH FINI DE LA STRAP

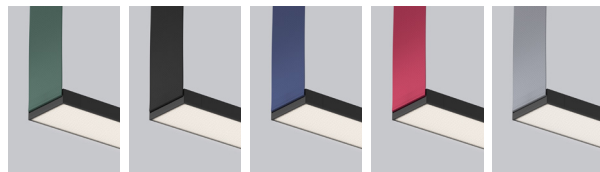

BGS

BLKS

OBS

PNS

SGS

## WIDTH & OVERALL HEIGHT REFERENCE

### RÉFÉRENCE POUR LA LARGEUR ET LA HAUTEUR HORS-TOUT

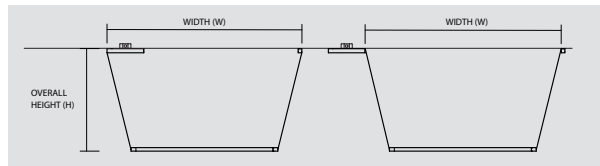

## MOUNTING OPTIONS OPTIONS DE MONTAGE

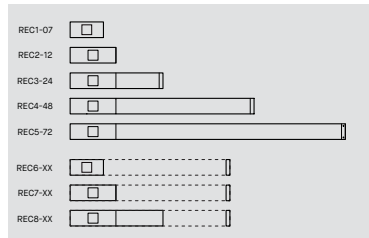

## PRODUCT CHARACTERISTICS CARACTÉRISTIQUES DU PRODUIT



## ORDERING SPECIFICATION SPÉCIFICATION DE COMMANDE

CODE

### MODEL MODÈLE

(WITHOUT SPACER)

- 74280-24 TANGRAM - TRACE 24"
- 74280-48 TANGRAM - TRACE 48"
- 74280-72 TANGRAM - TRACE 72"

(WITH SPACER, PLEASE SEE CONFIGURATION PAGE)

- 74280-L01 TANGRAM - TRACE 24" WITH ONE 24" SPACER
- 74280-L02 TANGRAM - TRACE 24" WITH TWO 24" SPACERS
- 74280-L03 TANGRAM - TRACE 24" WITH TWO SPACERS, ONE 24" & ONE 48"
- 74280-L04 TANGRAM - TRACE 48" WITH ONE 7" SPACER
- 74280-L05 TANGRAM - TRACE 48" WITH TWO 24" SPACERS
- 74280-L06 TANGRAM - TRACE 48" WITH ONE 72" SPACER
- 74280-L07 TANGRAM - TRACE 72" WITH ONE 24" SPACER
- 74280-L08 TANGRAM - TRACE 72" WITH ONE 48" SPACER
- 74280-L09 TANGRAM - TRACE 72" WITH ONE 72" SPACER
- 74280-L10\* TANGRAM - TRACE, TWO 24" WITH ONE CANOPY & TWO ANCHORS
- 74280-L11\* TANGRAM - TRACE, THREE 24" WITH TWO CANOPIES & TWO ANCHORS
- 74280-L12\* TANGRAM - TRACE, ONE 24", ONE 48" & ONE 72", WITH TWO CANOPIES & TWO ANCHORS

\* ONLY AVAILABLE WITH REC6, REC7 & REC8 MOUNTING OPTIONS

### LIGHT SOURCE SOURCE LUMINEUSE

- LED.LO LOW OUTPUT
- LED REGULAR OUTPUT
- LED.HO HIGH OUTPUT

### COLOR TEMPERATURE TEMPÉRATURE DE COULEUR

- 27 2700K
  - 30 3000K
  - 35 3500K
  - 40\* 4000K
- \* LONGER LEAD TIME MAY APPLY, PLEASE CONTACT YOUR EUREKA REPRESENTATIVE

### COLOR RENDERING INDEX (CRI) INDICE DE RENDU DE COULEUR (IRC)

- 90 90+ CRI

### VOLTAGE VOLTAGE

- 120V 120 VOLT
- 277V 277 VOLT

### CONTROL OPTION OPTION DE CONTRÔLE

- DV 0-10V DIMMING (120V-277V)
- DP PHASE DIMMING (120V ONLY) 24" (LOW, REG & HO), 48" (LOW & REG), 72" (LOW)
- NLTAIR2 NLIGHT AIR CONTROL GEN 2 (NOT AVAILABLE WITH REC1 & REC6 CANOPIES)
- NLIGHT NLIGHT WIRED CONTROL (NOT AVAILABLE WITH REC1 & REC6 CANOPIES)

### EMERGENCY BATTERY BATTERIE D'URGENCE

FOR 120-277V ONLY, EM DRIVER BOX INCLUDED, INSTALLED REMOTELY. SEE EM GUIDE FOR DETAILS

- EMB\* EMERGENCY BATTERY FOR REMOTE BOX

### MOUNTING MONTAGE

WITHOUT ANCHOR (FIXED WIDTH)

- REC1-07 7" RECTANGULAR CANOPY
- REC2-12 12" RECTANGULAR CANOPY
- REC3-24 24" RECTANGULAR CANOPY
- REC4-48 48" RECTANGULAR CANOPY
- REC5-72 72" RECTANGULAR CANOPY

WITH ANCHOR (CUSTOM WIDTH)

- REC6-XX\* 7" RECTANGULAR CANOPY WITH REMOTE ANCHOR
  - REC7-XX\* 12" RECTANGULAR CANOPY WITH REMOTE ANCHOR
  - REC8-XX\* 24" RECTANGULAR CANOPY WITH REMOTE ANCHOR (ONLY FOR L10, L11 & L12 TANGRAM MODELS)
- \* SPECIFY DISTANCE BETWEEN STRAPS (W), AT CEILING. PLEASE REFER TO ILLUSTRATION BELOW. FOR L10, L11 & L12 MODELS, SPECIFY THE TOTAL DISTANCE.

### OVERALL HEIGHT HAUTEUR HORS TOUT

- XX\* OVERALL HEIGHT
- \* SPECIFY OVERALL HEIGHT (H), FROM BOTTOM OF THE FIXTURE TO CEILING, IN INCHES.

### CANOPY FINISH FINI DU PAVILLON

- BLKE BLACK FINE TEXTURE
  - WHE WHITE FINE TEXTURE
  - XX\* CUSTOM RAL COLOR
- \* SPECIFY 4 DIGIT RAL CLASSIC CODE. LONGER LEAD TIME MAY APPLY, PLEASE CONTACT YOUR EUREKA REPRESENTATIVE.

### STRAP FINISH FINI DE LA STRAP

- BGS BRITISH RACING GREEN NYLON STRAP
- BLKS BLACK NYLON STRAP
- OBS OCEAN BLUE NYLON STRAP
- PNS PINOT NYLON STRAP
- SGS SILVERGRAY NYLON STRAP

### FIXTURE FINISH FINI DU LUMINAIRE

- BLKE BLACK FINE TEXTURE
  - WHE WHITE FINE TEXTURE
  - XX\* CUSTOM RAL COLOR
- SPACERS WILL HAVE THE SAME FINISH AS THE FIXTURE
- \* SPECIFY 4 DIGIT RAL CLASSIC CODE. LONGER LEAD TIME MAY APPLY, PLEASE CONTACT YOUR EUREKA REPRESENTATIVE.

### EMERGENCY BATTERY ACCESSORY ACCESSOIRE BATTERIE D'URGENCE

- 3981EA ELECTRICAL BOX FOR EMB EMERGENCY BATTERY

# TANGRAM – TRACE 74280 - WHITE TUNING

PROJECT PROJET
SPEC TYPE
NOTES

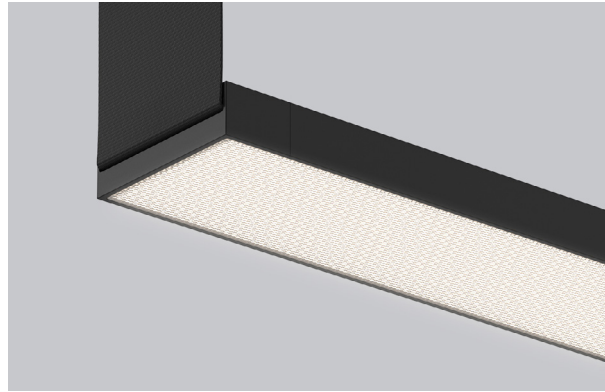

## FINISH FINI

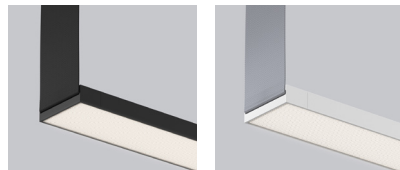

BLKE

WHE

## STRAP FINISH FINI DE LA STRAP

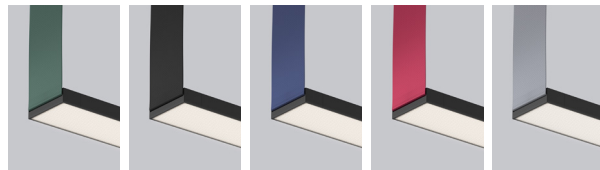

BGS

BLKS

OBS

PNS

SGS

## WIDTH & OVERALL HEIGHT REFERENCE

RÉFÉRENCE POUR LA LARGEUR ET LA HAUTEUR HORS-TOUT

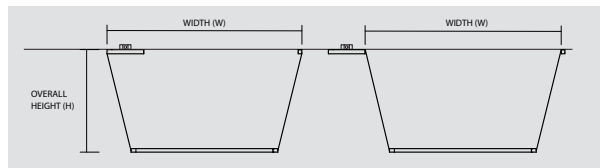

## MOUNTING OPTIONS OPTIONS DE MONTAGE

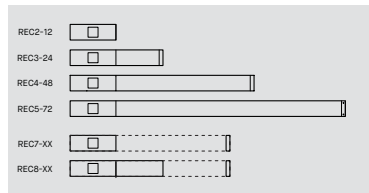

## ORDERING SPECIFICATION SPÉCIFICATION DE COMMANDE

CODE

### MODEL MODÈLE

(WITHOUT SPACER)

- 74280-24 TANGRAM - TRACE 24"
- 74280-48 TANGRAM - TRACE 48"
- 74280-72 TANGRAM - TRACE 72"

(WITH SPACER, PLEASE SEE CONFIGURATION PAGE)

- 74280-L01 TANGRAM - TRACE 24" WITH ONE 24" SPACER
  - 74280-L02 TANGRAM - TRACE 24" WITH TWO 24" SPACERS
  - 74280-L03 TANGRAM - TRACE 24" WITH TWO SPACERS, ONE 24" & ONE 48"
  - 74280-L04 TANGRAM - TRACE 48" WITH ONE 7" SPACER
  - 74280-L05 TANGRAM - TRACE 48" WITH TWO 24" SPACERS
  - 74280-L06 TANGRAM - TRACE 48" WITH ONE 72" SPACER
  - 74280-L07 TANGRAM - TRACE 72" WITH ONE 24" SPACER
  - 74280-L08 TANGRAM - TRACE 72" WITH ONE 48" SPACER
  - 74280-L09 TANGRAM - TRACE 72" WITH ONE 72" SPACER
  - 74280-L10\* TANGRAM - TRACE, TWO 24" WITH ONE CANOPY & TWO ANCHORS
  - 74280-L11\* TANGRAM - TRACE, THREE 24" WITH TWO CANOPIES & TWO ANCHORS
  - 74280-L12\* TANGRAM - TRACE, ONE 24", ONE 48" & ONE 72", WITH TWO CANOPIES & TWO ANCHORS
- \* ONLY AVAILABLE WITH REC6, REC7 & REC8 MOUNTING OPTIONS

### LIGHT SOURCE SOURCE LUMINEUSE

LED REGULAR OUTPUT

### COLOR TEMPERATURE TEMPÉRATURE DE COULEUR

TW\* TUNABLE WHITE (2700K TO 5000K)  
\* LONGER LEAD TIME MAY APPLY, PLEASE CONTACT YOUR EUREKA REPRESENTATIVE

### COLOR RENDERING INDEX (CRI) INDICE DE RENDU DE COULEUR (IRC)

80 80+ CRI

80

### VOLTAGE VOLTAGE

120V 120 VOLT  
277V 277 VOLT

### CONTROL OPTION OPTION DE CONTRÔLE

DDV DUAL 0-10V DIMMING  
NTL NLIGHT NTUNE CONTROL

### MOUNTING MONTAGE

WITHOUT ANCHOR (FIXED WIDTH)

- REC2-12 7" RECTANGULAR CANOPY
- REC3-24 12" RECTANGULAR CANOPY
- REC4-48 24" RECTANGULAR CANOPY
- REC5-72 48" RECTANGULAR CANOPY

WITH ANCHOR (CUSTOM WIDTH)

- REC7-XX\* 12" RECTANGULAR CANOPY WITH REMOTE ANCHOR
  - REC8-XX\* 24" RECTANGULAR CANOPY WITH REMOTE ANCHOR (ONLY FOR L10, L11 & L12 TANGRAM MODELS)
- \* SPECIFY DISTANCE BETWEEN STRAPS (W), AT CEILING. PLEASE REFER TO ILLUSTRATION BELOW. FOR L10, L11 & L12 MODELS, SPECIFY THE TOTAL DISTANCE.

### OVERALL HEIGHT HAUTEUR HORS TOUT

XX\* OVERALL HEIGHT  
\* SPECIFY OVERALL HEIGHT (H), FROM BOTTOM OF THE FIXTURE TO CEILING, IN INCHES.

### CANOPY FINISH FINI DU PAVILLON

- BLKE BLACK FINE TEXTURE
  - WHE WHITE FINE TEXTURE
  - XX\* CUSTOM RAL COLOR
- \* SPECIFY 4 DIGIT RAL CLASSIC CODE. LONGER LEAD TIME MAY APPLY, PLEASE CONTACT YOUR EUREKA REPRESENTATIVE.

### STRAP FINISH FINI DE LA STRAP

- BGS BRITISH RACING GREEN NYLON STRAP
- BLKS BLACK NYLON STRAP
- OBS OCEAN BLUE NYLON STRAP
- PNS PINOT NYLON STRAP
- SGS SILVERGRAY NYLON STRAP

### FIXTURE FINISH FINI DU LUMINAIRE

- BLKE BLACK FINE TEXTURE
  - WHE WHITE FINE TEXTURE
  - XX\* CUSTOM RAL COLOR
- SPACERS WILL HAVE THE SAME FINISH AS THE FIXTURE  
\* SPECIFY 4 DIGIT RAL CLASSIC CODE. LONGER LEAD TIME MAY APPLY, PLEASE CONTACT YOUR EUREKA REPRESENTATIVE.

## PRODUCT CHARACTERISTICS CARACTÉRISTIQUES DU PRODUIT



# TANGRAM – TRACE 74280

ALL CONFIGURATIONS BELOW ARE SHOWN WITH AN 60" OVERALL HEIGHT.



**74280-L01**  
24" FIXTURE. ONE 24" SPACER AT THE FIRST THIRD OF THE TOTAL HEIGHT.  
SHOWN WITH A REC3-24 CANOPY.

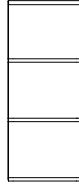

**74280-L02**  
24" FIXTURE. TWO 24" SPACERS AT EACH THIRD OF THE TOTAL HEIGHT.  
SHOWN WITH A REC3-24 CANOPY.

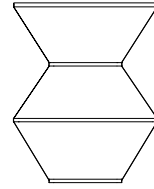

**74280-L03**  
24" FIXTURE. ONE 48" SPACER AT THE FIRST THIRD AND ONE 24" SPACER AT THE SECOND THIRD.  
SHOWN WITH A REC4-48 CANOPY.

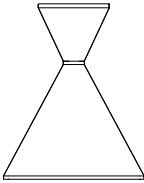

**74280-L04**  
48" FIXTURE. ONE 7" SPACER AT THE SECOND THIRD OF THE TOTAL HEIGHT.  
SHOWN WITH A REC3-24 CANOPY.

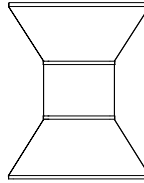

**74280-L05**  
48" FIXTURE. TWO 24" SPACERS AT EACH THIRD OF THE TOTAL HEIGHT.  
SHOWN WITH A REC4-48 CANOPY.

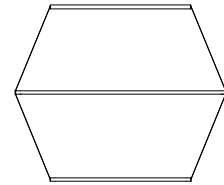

**74280-L06**  
48" FIXTURE. ONE 72" SPACER AT THE MIDDLE OF THE TOTAL HEIGHT.  
SHOWN WITH A REC4-48 CANOPY.

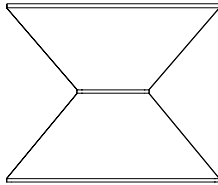

**74280-L07**  
72" FIXTURE. ONE 24" SPACER AT THE MIDDLE OF THE TOTAL HEIGHT.  
SHOWN WITH A REC5-72 CANOPY.

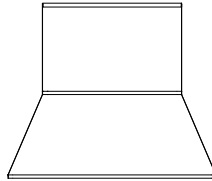

**74280-L08**  
72" FIXTURE. ONE 48" SPACER AT THE MIDDLE OF THE TOTAL HEIGHT.  
SHOWN WITH A REC3-24 CANOPY.

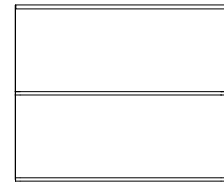

**74280-L09**  
72" FIXTURE. ONE 72" SPACER AT THE MIDDLE OF THE TOTAL HEIGHT.  
SHOWN WITH A REC5-72 CANOPY.

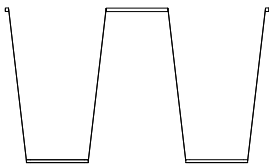

**74280-L10**  
24" FIXTURES WITH TWO ANCHORS.  
SHOWN WITH THE REC8 CANOPY OPTION AND A 108" TOTAL WIDTH.

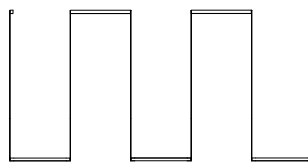

**74280-L11**  
24" FIXTURES.  
SHOWN WITH THE REC8 CANOPY OPTION AND A 120" TOTAL WIDTH.

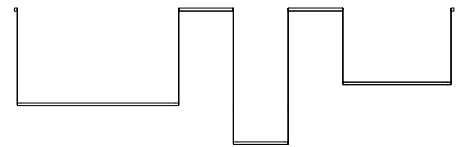

**74280-L12**  
ONE 24" FIXTURE, ONE 48" FIXTURE AT THE MIDDLE OF THE TOTAL HEIGHT AND ONE 72" FIXTURE AT THE FIRST THIRD OF THE TOTAL HEIGHT.  
SHOWN WITH THE REC8 CANOPY OPTION AND A 192" TOTAL WIDTH.

## CUSTOM CONFIGURATIONS

FOR CUSTOM CONFIGURATIONS, SIMPLY CONTACT THE FACTORY AND WE WILL BE PLEASED TO DISCUSS YOUR DESIGN REQUIREMENTS.

# TANGRAM TRACE - 74280

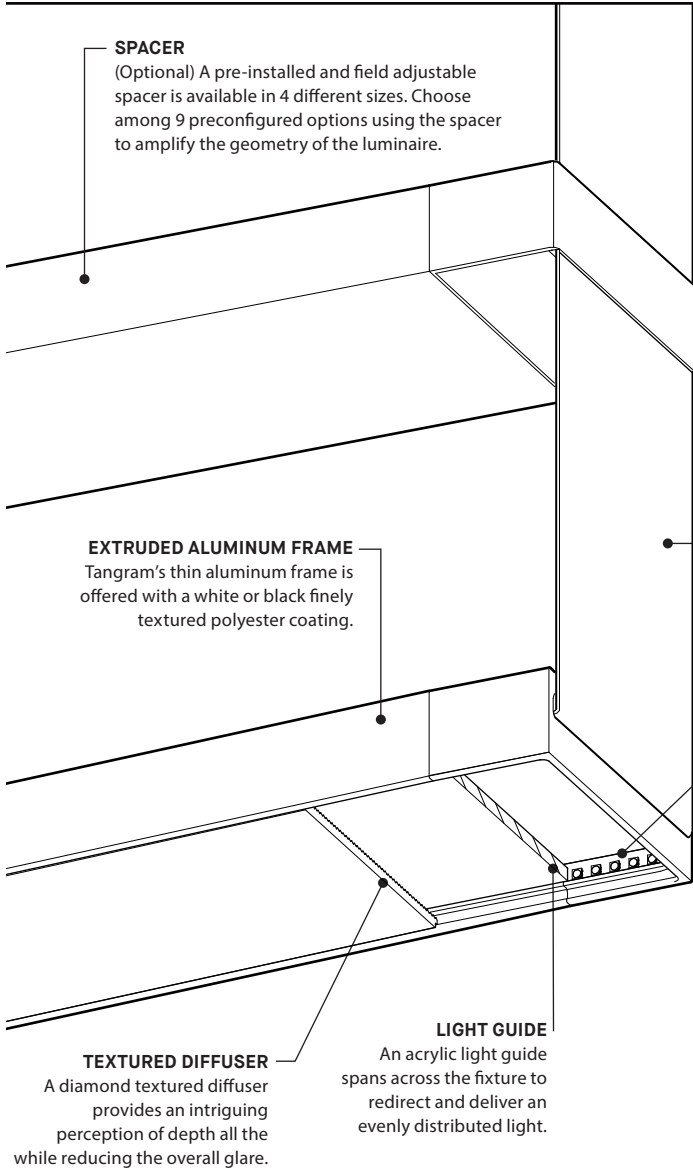

## CUSTOM WIDTH

Canopy and anchor distance can be specified to create a variety of strap angles. They can be positioned inside or outside as desired.

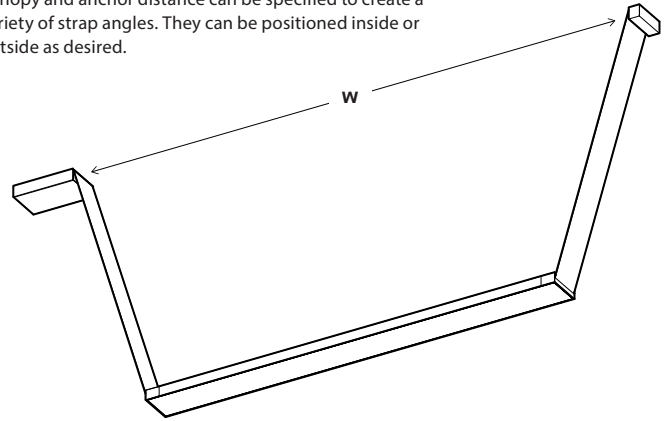

## STRAP SUSPENSION

Fixture is suspended by two high quality UV resistant nylon straps housing an imperceptible flat power cable. Available in 5 eye-catching colors.

## HIGH QUALITY LED

A single high rendering quality LED strip illuminates Tangram's edge lit surface. Also available in tunable white.

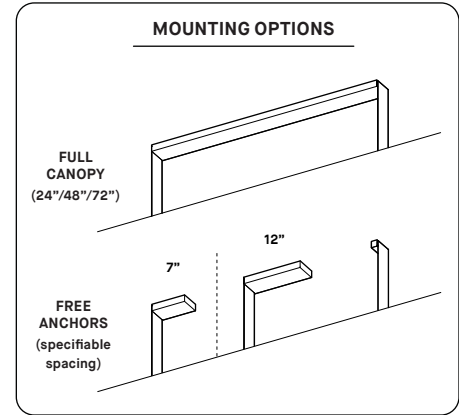

## LIGHT SOURCE SIZES

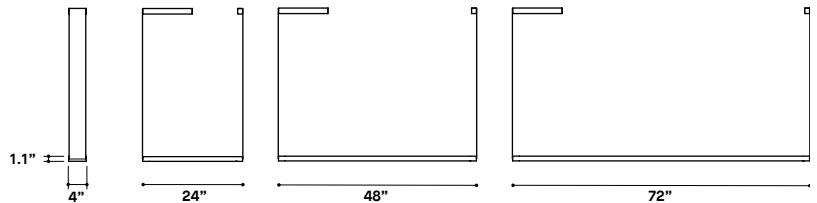

PRODUCT SPECIFICATION	74280-24				74280-48				74280-72			
	LOW	REG	HO	TW	LOW	REG	HO	TW	LOW	REG	HO	TW
<b>PERFORMANCE</b>												
SYSTEM WATTAGE	13,5 W	17,7 W	22,1 W	15,6 W	27,1 W	35,5 W	44,2 W	31,2 W	40,6 W	53,2 W	66,2 W	46,8 W
DELIVERED LUMENS (4000K - WHE)	1339 LM	1701 LM	2053 LM	1521 LM	2679 LM	3402 LM	4107 LM	3042 LM	4018 LM	5102 LM	6160 LM	4564 LM
DELIVERED LUMENS/FEET (4000K - WHE)	683 LM/FT	867 LM/FT	1046 LM/FT	775 LM/FT	683 LM/FT	867 LM/FT	1046 LM/FT	775 LM/FT	683 LM/FT	867 LM/FT	1046 LM/FT	775 LM/FT
EFFICACY	99 LM/W	96 LM/W	93 LM/W	97 LM/W	99 LM/W	96 LM/W	93 LM/W	97 LM/W	99 LM/W	96 LM/W	93 LM/W	97 LM/W
<b>OTHER INFORMATION</b>												
LUMINAIRE'S WEIGHT	3 LBS / 1,4 KG				6 LBS / 2,8 KG				9 LBS / 4,2 KG			
L70 (LUMEN MAINTENANCE) LO/REG/HO	> 60 000 HRS				> 60 000 HRS				> 60 000 HRS			

## EFFICACY MULTIPLIERS

CCT	FACTOR	TW FACTOR
5000K	-	0.93
4000K	1.00	1.00
3500K	0.97	0.99
3000K	0.93	0.98
2700K	0.89	0.91

## LIGHT DISTRIBUTION

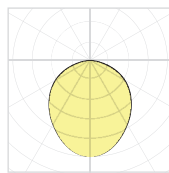

74280



Visit our website for warranty terms and conditions.



## TECHNICAL DATA

# TANGRAM TRACE - 74280

## CONFIGURATION GUIDE

### STEP 1 - CHOOSE YOUR FIXTURE

Choose among a variety of 9 preconfigurations. Refer to specification sheet to view all available options.



74280-24

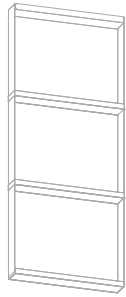

74280-L02

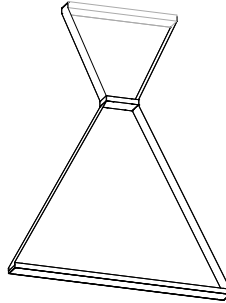

74280-L04

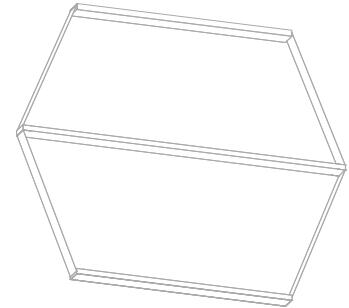

74280-L06



### STEP 2 - CHOOSE YOUR MOUNTING OPTION AND OVERALL WIDTH (W)

Change the look of your fixture by selecting a different mounting option and customizing the width between the anchors for distinct strap angles.

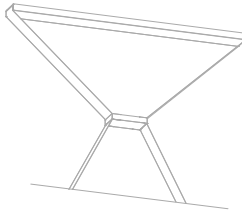
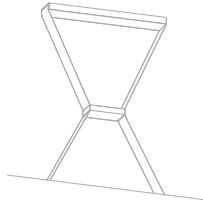
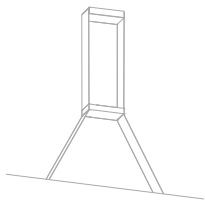

**FULL LENGTH CANOPY**  
FIXED WIDTH

OR

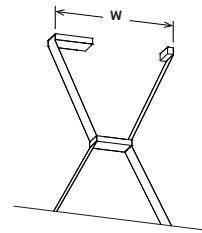

**W = 24"**

**CANOPY WITH ANCHOR**  
SPECIFY OVERALL WIDTH (W)

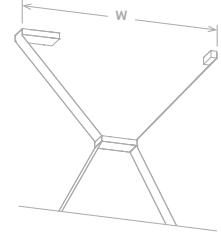

### STEP 3 - SPECIFY OVERALL HEIGHT

Specify the overall height from the bottom of the fixture to the ceiling preserving the same component height proportions.

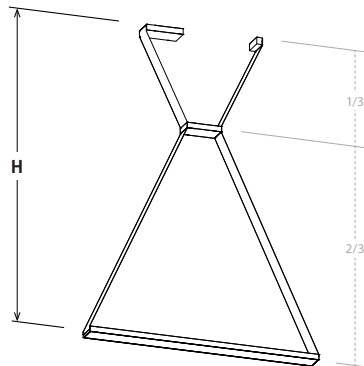
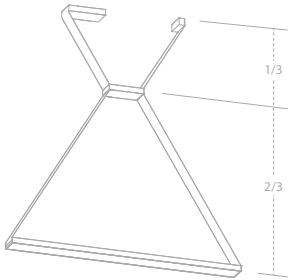

**H = 66"**

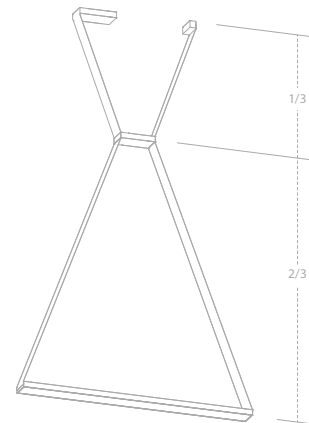

# Strap Material Color Options



Eureka Code	<b>BGS</b> British Racing Green	<b>BLKS</b> Black	<b>OBS</b> Ocean Blue	<b>PNS</b> Pinot	<b>SGS</b> Silver Gray
Pantone Color Match	350 U	Standard Black	282 U	7638 C	Cool Gray 9 U
SUGGESTED COMBINATIONS					
Eureka Finish Combo	PGE*	BLKE	NBE	N/A	LGE*
RAL K7 Combo	6021*	9004	5000	3004*	7004*
Eureka Felt Combo	DTF Deep Teal Green*	BBF Black	OBF Ocean Blue	PNF Pinot Noir	TGF Titanium Gray

\*Tone-on-tone combo

— Colors shown for visual reference only. To visualize finishes properly, use appropriate Pantone color chart, RAL color chart or felt samples.